

Digital Apartment Video Intercom User Guide



Content

1. System Installation Diagram	3
1.1 Apartment Wiring	3
1.2 High Level Wiring Diagram	4
1.3 Villa Wiring Diagram	5
1.4 Indoor Monitor Diagram	7
2. Monitor Operation Instruction	8
2.1 Main GUI	8
2.2 Recording Center	10
2.2.1 Photo Record	10
2.2.2 Call Record	10
2.2.3 Message Record	11
2.2.4 Arming Record	12
2.2.5 Alarm Record	12
2.2.6 Motion Detection Record	12
2.3 Security	13
2.4 Monitoring Center	13
2.5 Video Intercom	14
2.5.1 Call Room (only for apartment and high level system)	14
2.5.2 Internal Call Between Indoor Monitor Extension	14
2.5.3 Cloud Intercom	15
2.5.4 Video Intercom (only for apartment system)	19
2.5.5 Telephone Book (only for apartment system)	20
2.6 User Settings	20
2.6.1 System Info	21
2.6.2 Ringtone Setting	21
2.6.3 Time & Date Setting	22
2.6.4 Passcode Setting	22
2.6.5 Volume Setting	23
2.6.6 Language Setting	23
2.6.7 Screen Brightness Setting	24
2.6.8 Wallpaper Setting	24
2.6.9 Screen Saver Setting	25
2.6.10 Delay Setting	26
2.6.11 Time Zone Setting	26
2.7 System Setting	27

1 System Installation Diagram

2.7.1 Security Setting	27
2.7.2 Monitor Extension Setting	27
2.7.3 Outdoor Station Setting	29
2.7.4 System Password Setting	30
2.7.5 System Reset	30
2.7.6 IP Camera Setting	31
2.7.7 Color Adjustment	32
2.7.8 Software Upgrade	32
2.7.9 Record Mode Setting	33
2.7.10 Outdoor Station Parameters Resetting	33
2.7.11 Card (only for High Level System)	34
2.7.12 Fingerabdruck (only for High Level System)	34

3. Technical Parameter -----35

4. Installation Diagram -----35

1.1 Apartment Wiring Diagram

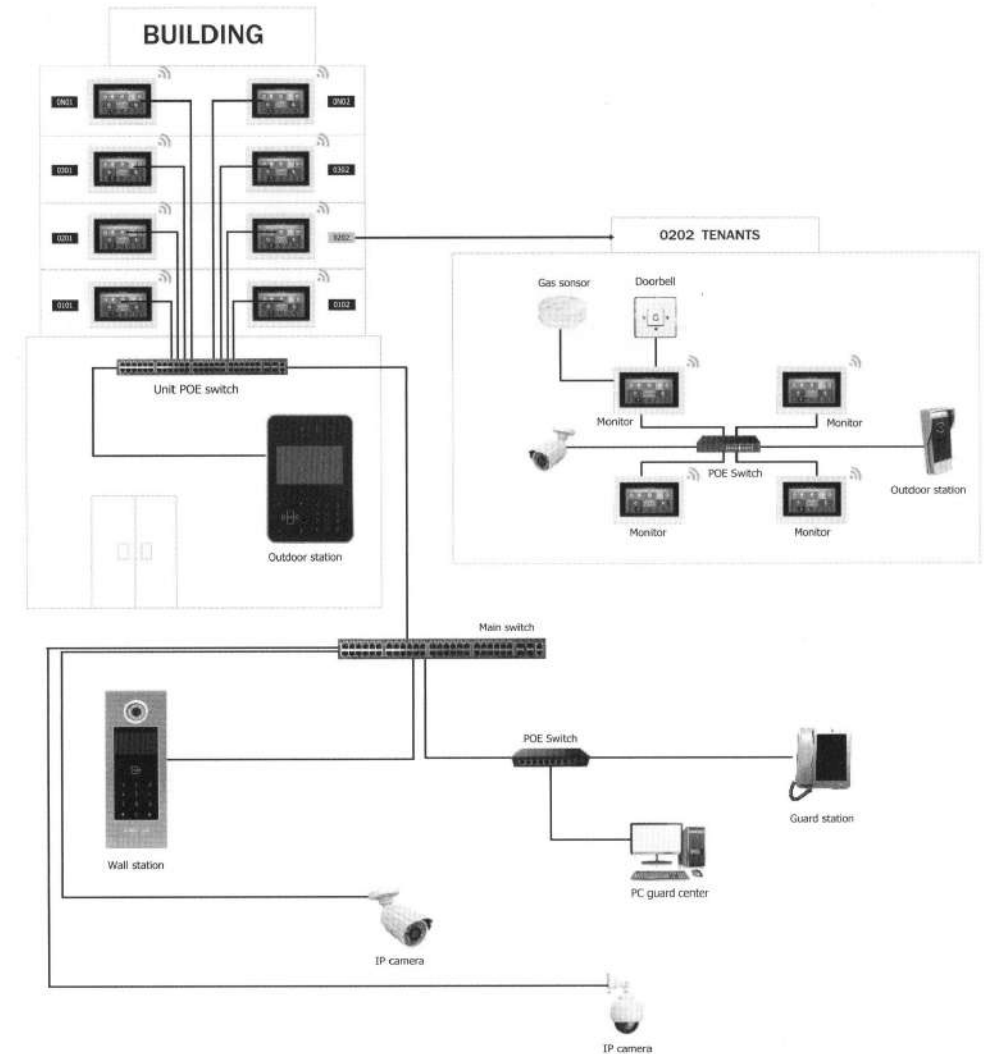

1.2 High Level Wiring Diagram

System Diagram With PoE

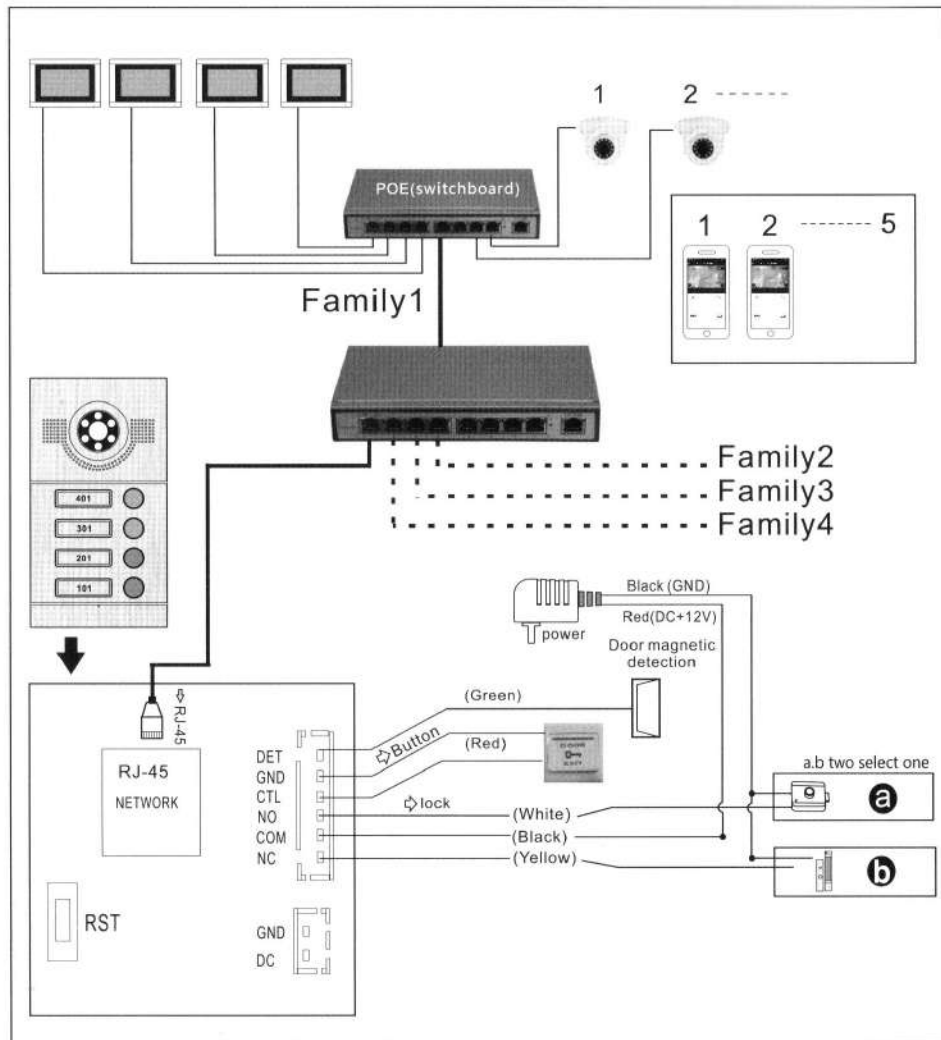

Note: Optional for POE function Outdoor station not need extra power supply when with built-in POE function.

1.3 Villa Wiring Diagram

Multiple Devices

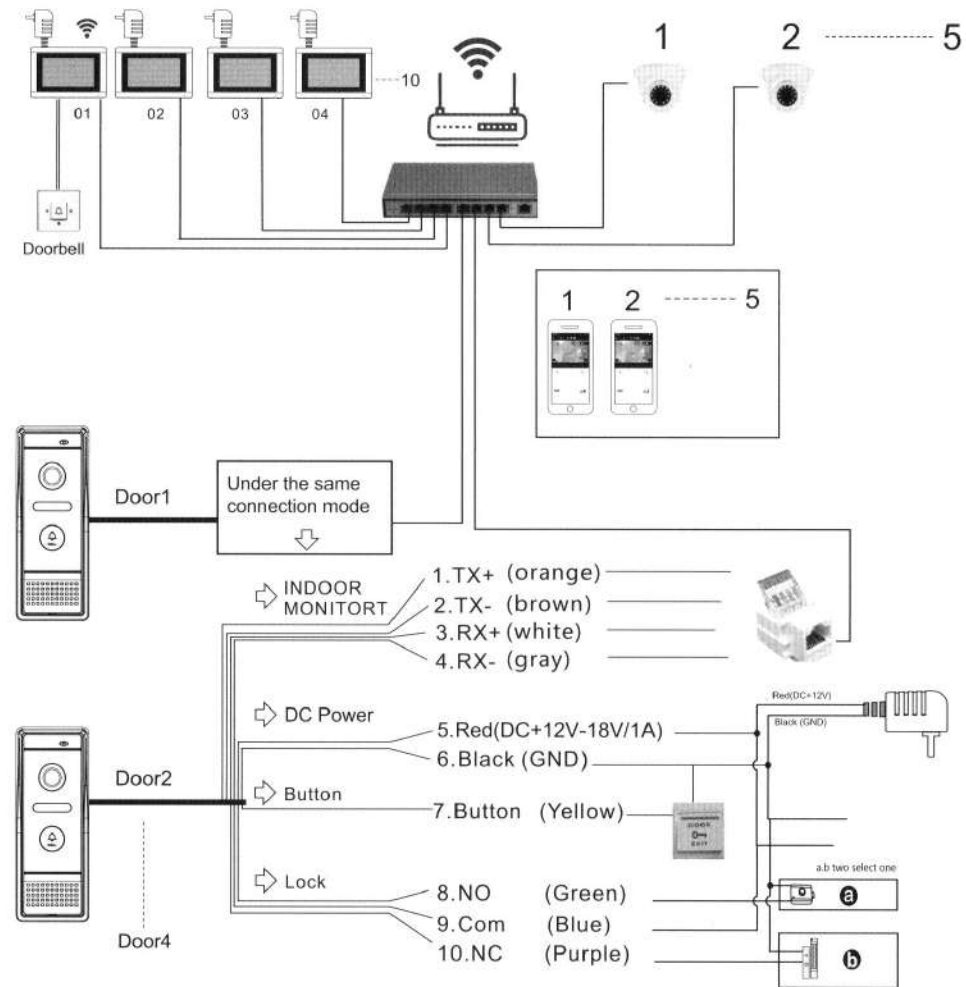

Note: Support PoE Function if use PoE splitter in outdoor station.

One to One

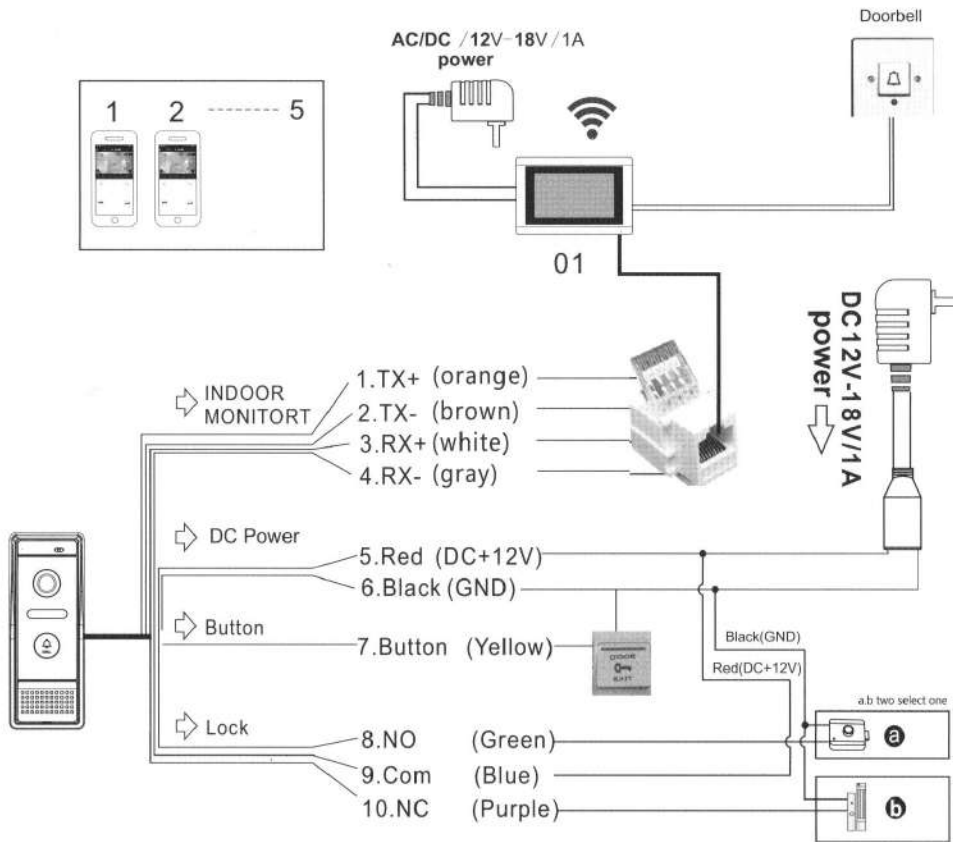

Note: Support PoE Function if use PoE splitter in outdoor station.

1.4 Indoor Monitor Diagram

Type A indoor monitor diagram

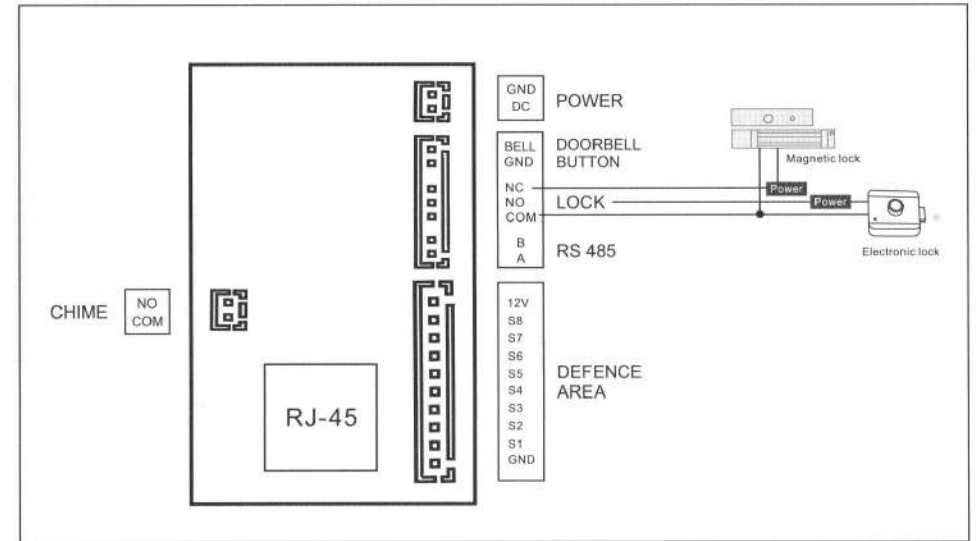

Type B indoor monitor diagram

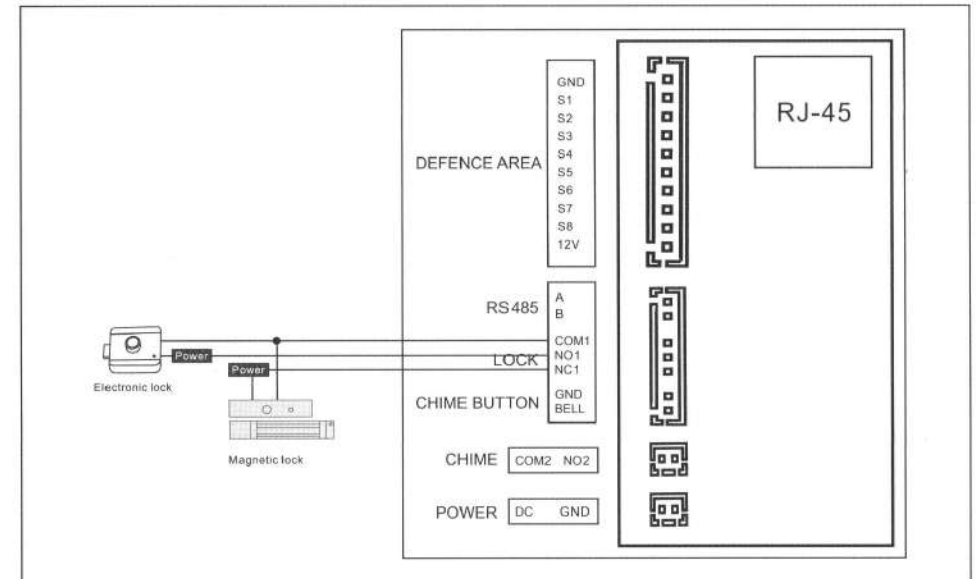

2 Monitor Operation Instruction

2.1 Main GUI

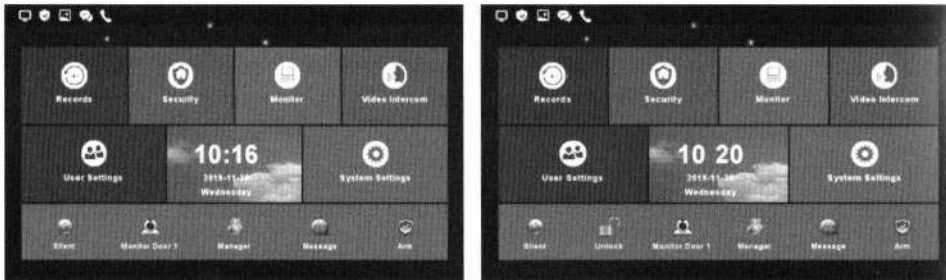



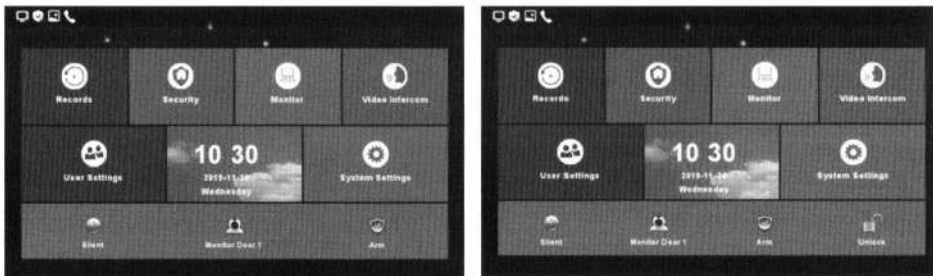

Apartment System Main GUI





















High Level, Villa System Main GUI

- 1) There are Menu, Shortcut keys, Status
- 2) Menu including: recording center, security zone, monitoring center, video intercom, user setup, system setup
- 3) Shortcuts Introduction

Shortcut Icon	Shortcut Name	Funciton
	Ringtone On/Off	Turn On/Off button ringtone or call ringtone
	Door 1 Monitoring	Monitor outdoor station 1
	Arm	One Key Arm
	Unlock	Unlock the lock connected with the indoor monitor optional function
	Managing Center	Call Guard Station or PC Managing Center. The call will go to PC Managing Center only when the Guard Station offline or no answer.(only for apartment system)
	Community Message	Quick browse community message (Only for Apartment System)

4) Status Icon Instruction

- ① Network status:  Connected,  Disconnected,  Network Conflict.
- ② Security status:  Arm,  Disarming,  Alarming.
- ③ Unread message: 
- ④ Missed call: 
- ⑤ Unread public message: 

Network	Connected	Disconnected	IP Conflict
			
Security Status	Arm	Disarming	Alarming
			
Others	Unread Message	Missed Call	Unread public message
			

2.2 Recording Center

2.2.1 Photo Record

Storage calls, motion detections, snapshot pictures. Click "View" button can review the snapshot pictures.



2.2.2 Call Record

- 1) The device will save the call records which includes Missed Call, Dialed Call, Received Call and records in details (Date, Time, Read Status).
- 2) Choose the corresponding device and Click "View"  to check the records in details included pictures or videos.



- 3) Redialing the extension monitor when "Redial"  is available to click after you selected a related record from "Missed, Received, Dialed". Meanwhile, you can delete a record or all records after selected.



2.2.3 Message Record

Store missed calls records visitor can leave "Voice or Video Message" to householder, if there is no response after the outdoor station is pressed. And click "View" to know the message details included Device Info, Date Time, Record Status after you selected one record.

Meanwhile, you can delete a recorder all records after selected.



2.2.4 Arming Record

When you selected one record, click “View” to know the arming record in details included Operations Record, Time. Meanwhile, you can delete a records after selected.



2.2.5 Alarm Record

When you selected one record, click “View” to know the alarm record in details included alarm location, Alarm Type, Time. Meanwhile, you can delete a record or all records after selected.



2.2.6 Motion Detection Record

Motion Detection Record included Extension Monitor Info, Time, Status. When you selected one record, click “View” to know the record details. Meanwhile, you can delete a record or all records after selected.

Noted: Motion detection function happened on villa outdoor station or front door call panel only.



2.2.7 Community message (only for apartment system)

Storage and manage the public and personal messages that launched by the Manage Center, include Subject, Date, Time, Read, Unread. Details are viewable, and deletable.

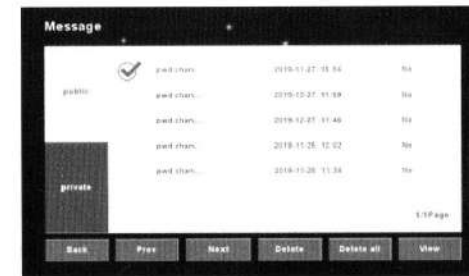

2.3 Security

“Security Interface” have 8 security zone status included Security Zone Location, Arming Type, Arming Status. Support “One click to Arm or Disarm all 8 security zone together”.



2.4 Monitoring Center

Available to monitor all the outdoor stations, villa call panel (front door call panel), IP camera, and can snapshot pictures and unlock at the monitor interface. The monitor time is 1min.

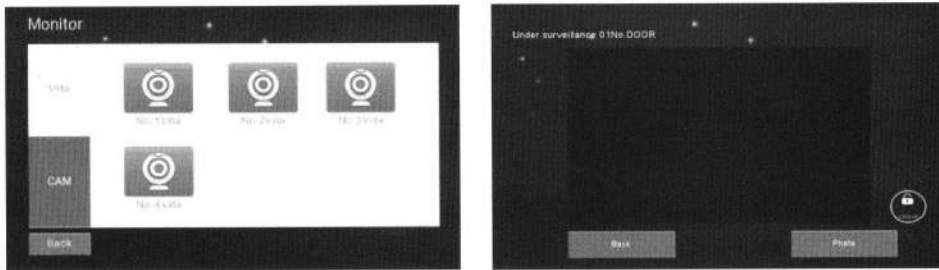

2.5 Video Intercom

2.5.1 Call Room (only for apartment and high level system)

It can call to any online monitor which using same LAN with it,(can not call itself), input room number and call.

Internal intercom switch: After enable this function, user can be called by other users, tap the switch to become blue means enabled.



2.5.2 Internal Call Between Indoor Monitor Extension

The function supports inner calls between the indoor monitors. After set the indoor monitor room number, all indoor monitor extensions support "Click to call the monitor extension" or "the other is not online" if the monitor extension is not setting successfully or offline. Noted: If monitor room number is default, then there is no extension for it.



2.5.3 Cloud Intercom

When the bell is pressed, there will be a notification in the smart phone.

Note: Only the monitor which is set as 01 or by default has cloud intercom function. Please operate it on the 01 monitor.

APP download & Regist

- ① Before WiFi Connection, download "Tuya smart" app in Android Market, or IOS at APPstore.
- ② Run App, and regist. Please note to select the country and region.
- ③ APP Login after regist.

AP mode connection steps:

- ① After the indoor monitor powered on, it will automatically create a hotspot named in SmartLife-xxxxxx. (Xxxxxx is the last six digits of the device's MAC address. When using the AP mode, you can find the corresponding hotspot for network configuration according to the last six digits of the device's MAC address)
- ② Turn on smartphone "Settings" --> "Wi-Fi" to check if you can search SmartLife-xxxxxx hotspot. If it is there, go to step 4. If can't find it, go to step 3.
- ③ Indoor monitor go to Video Intercom>Cloud Intercom>Wifi Connection, click "Valid" to turn on AP mode, and then indoor monitor will auto reboot and create a hotspot "SmartLife-xxxxxx"
- ④ Run Tuya smart APP on your phone, click "Add Device" to add new device. (pic 1).
- ⑤ Select "Video Surveillance" > "Smart Doorbell" category (pic 2).



pic 1



pic 2



pic 5

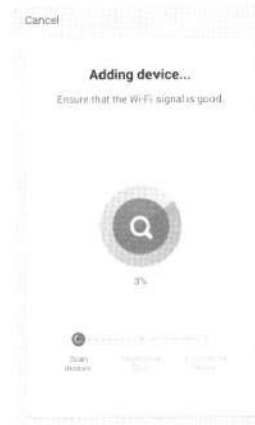

pic 6

- ⑥ Tap ⇐ button on the top right corner > “AP mode”, click “next step” (pic 3).
- ⑦ Input your WiFi name and password, then click “Next” (pic 4).

APP Interface Introduction

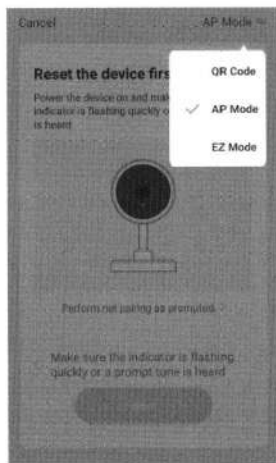

pic 3



pic 4

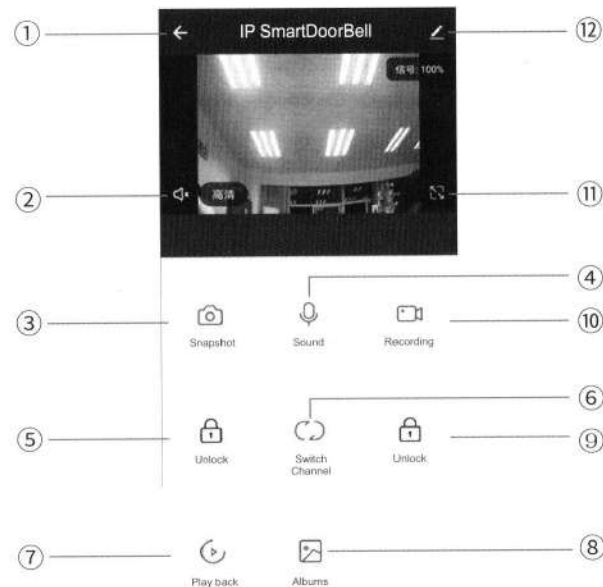

- ⑧ Click “Go to Connect”, switch to “Wi-Fi” connection page, find SmartLife-xxxxxx hotspot and connect it, then back to Tuya smart APP, it will show below interface (pic 5).
- ⑨ Wait for the progress to be 100% complete, after the device is successfully added it will go to the following interface (pic 6).

- ① Hang up (back): exist the interface when press this icon while talking or monitoring.
- ② Speaker: Can hear the voice from outdoor station when turn on, and no voice when turn off. Can not talk while monitoring.
- ③ Picture snapshot: Can snapshot the images while talking or monitoring.
- ④ Micphone: Call panel calls and answered on smartphone, turn on this icon, the micphone is on, the voice can go to outdoor station. If not turned on, outdoor station cannot hear the voice from smartphone. This functions is invalid while monitoring.
- ⑤ Outdoor Unlock: Can unlock the lock connected to the call panel while talking or monitoring.
- ⑥ Channel switch: Can switch to monitor other call panels while talking or monitoring. Have 4 channels includes DOOR1, DOOR2, DOOR3, DOOR4, and matches to apartment system or high level system is NO.1 DOOR, NO.2 DOOR, NO.3 DOOR, NO.1 Villa, and matches to villa system is NO.1 Villa, NO. 2 Villa, NO.3 Villa, NO.4 Villa.
- ⑦ Play back: Click here for video play back when have SD card in the monitor and Recording function on APP is on.
- ⑧ Pictures: The snapshot pictures or recorded videos while talking or monitoring saved here. (only for Android smartphone, for IOS phone, it saved in Camera on smartphone.)
- ⑨ Monitor Unlock: Unlock the lock that connected to the indoor monitor while talking or monitoring. (only for the indoor monitor has monitor relay function).
- ⑩ Video Recording: Start record video while talking or monitoring.
- ⑪ Full Screen: display the image full screen.
- ⑫ Settings

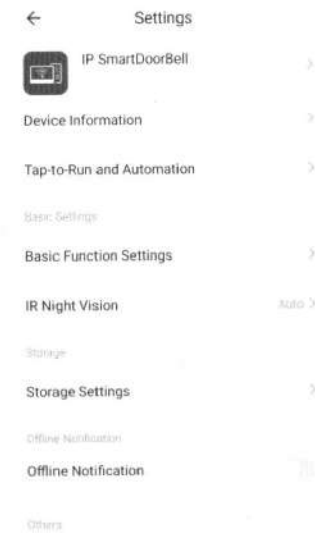

- a. Available to, modify the device name.
- b. Available to view the device info.
- c. Available to set the talking mode as single model or double mode at basic settings (Default as single mode).
- d. Have Saving Settings if indoor monitor has SD card. Can view the storage capacity, the event records when the video recording mode is on.
- e. Available to share the device to other smartphone.
- f. Delete the device if need to unbin the device from the smartphone.

2.5.4 Video Intercom (only for apartment system)

Available to call the Guard Station or PC Management Center, and can snapshot pictures.



2.5.5 Telephone Book (only for apartment system)

Available to add the contacts that besides own apartment, and call to others. Fill in the Contact name, area, building, unit, room number when add. Can have audio call after added.

Notes: The contacts that added here need to make sure in the same network, and need to setup in the indoor monitor.

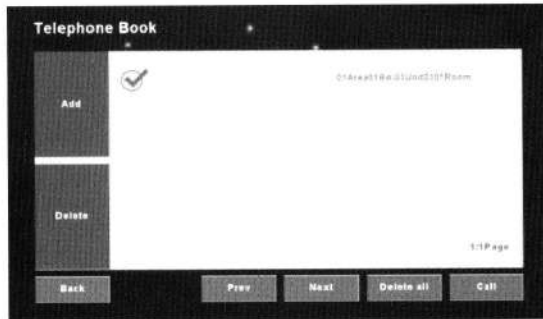

2.6 User Settings

Click to enter "User Settings Interface".

••• : Click "One Circle Button" to enter the next user settings page.

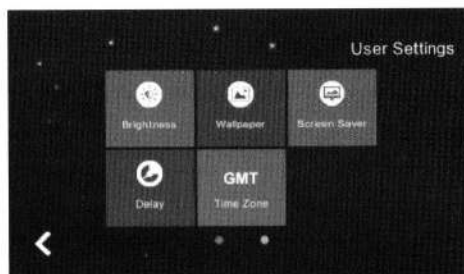
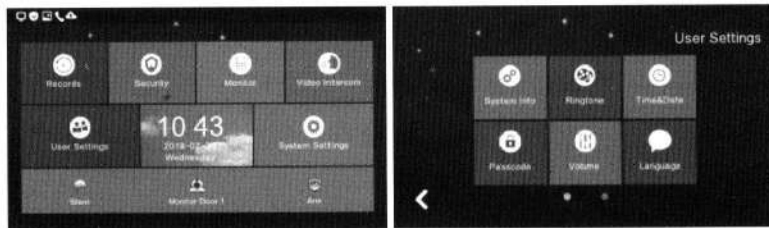

2.6.1 System Info

Click "System Info" to know the details: Extension code, IP address 1(wired network card IP address), Mask, Gateway, Network configuration version, Software version, MAC Address, IP Address 2(wireless network card IP address), PID and ID, SD card capacity.

Format: Format SD card.

Read: Insert the SD card which is with the ID file into the monitor, click "read" to get the ID number.

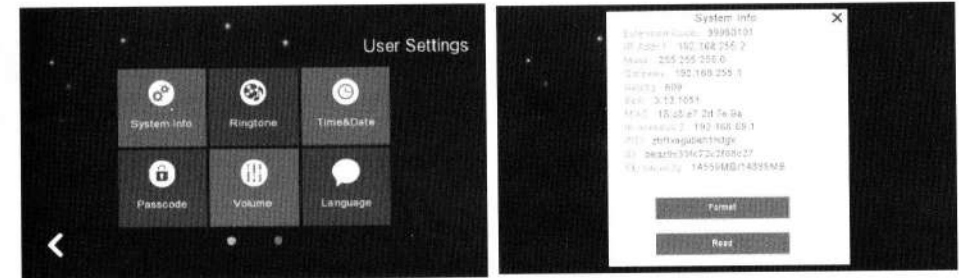

2.6.2 Ringtone Setting

Support to set the ringtone when the indoor monitor call other device or is called by other device.

Available to select the ringtone in "ring" folder from SD Card.

When you selected one ringtone and click "Listen" for the audition.



2.6.3 Time & Date Setting

- 1) 24-hour time system as the default and available to set Year / Month / Day / Hour / Minute, Save after setting.
- 2) Format switch: switch the Date format as Y/M/D, D/M/Y, M/D/Y.

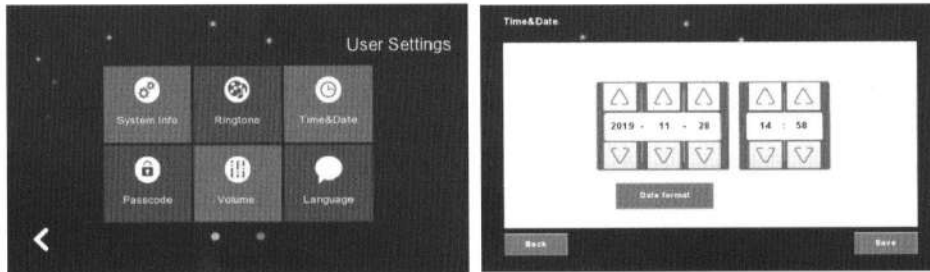

2.6.4 Passcode Setting

The Passcode is for Disarm and Unlock. Unlck passcode is only for apartment system, and work with the apartment outdoor station. Disarm Passcode is for disarm after setup arm in the indoor monitor. When changing the passcode, please enter original passcode (the original passcode by default is 123456), and enter the new passcode for twice and click “Confirm”, then it will change successfully.

Notice: It is not available to use 6 same numbers for setting.

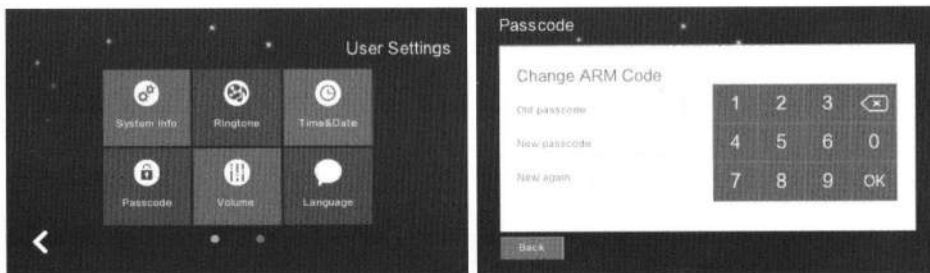

2.6.5 Volume Setting

- 1) Click “Volume” to enter the setting and the below button is to adjust the volume of “Ringtone / Touch Key or Talk”, and there would be the audition after you adjusted the volume ,that need to Click “OK” to set successfully if you adjusted the volume.

- △ : Increase the volume (+)
- ▽ : Decrease the volume (-)

Note: “ 6 ” as the default volume and the volume range is “ 0-15 ”.

- 2) Key tone switch: turn on or off the key tone, click it to turn dark blue means turn on.
- 3) Voice Message On/Off: Remind to leave messages when not answered the call from the visitor at outdoor sation. Default is off, click to dark blue is on.

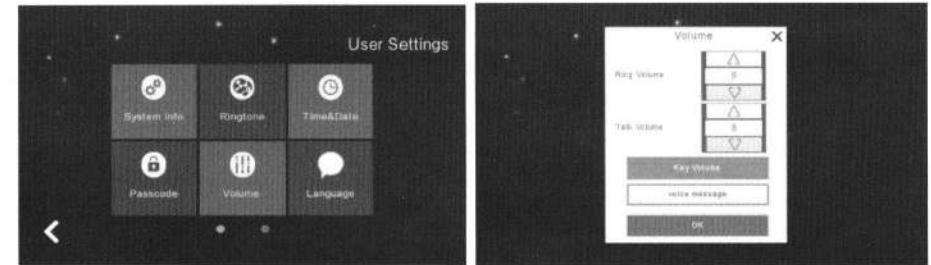

2.6.6 Language Setting

Click “Language” to enter the setting, and it is available for Russian, English, Spanish, Turkish, Portuguese, German, French, Italian, Polish, Bulgarian, Arabic, Azerbaijani, Persian, Dutch.

When selected one language and need to click “OK” to set successfully.

- “Prev”: Page Up
- “Next”: Page Down

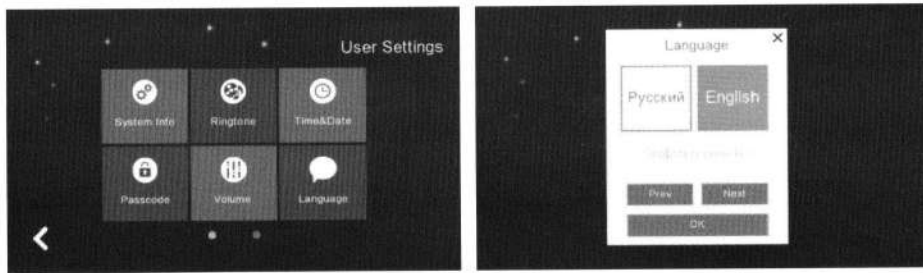

2.6.7 Screen Brightness Setting

Click “Brightness” to enter the setting, then, adjust the brightness accordingly and need to Click “OK” to set successfully if you adjusted the brightness.

▲ : Increase the brightness (+)

▼ : Decrease the brightness (-)

Note: The brightness range is “1-100”.

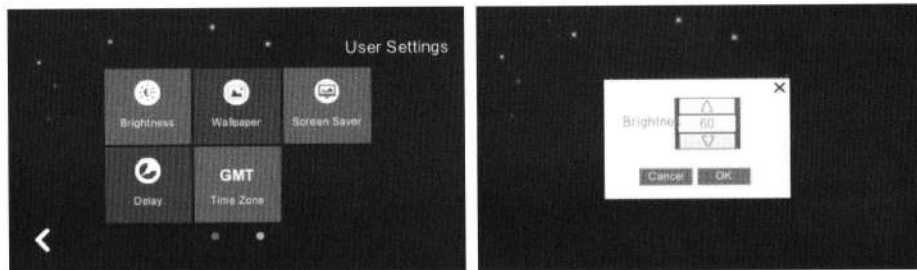

2.6.8 Wallpaper Setting

Click “Wallpaper” to enter the setting, and when selected one picture, click “Set as wallpaper” to set successfully. And it is available for selecting the picture in “Wallpaper” folder from SD Card.

Note: Picture resolution should be “1024*600” and “JPG format”

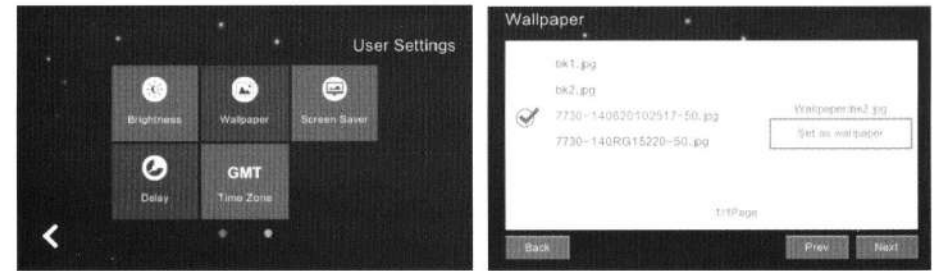

2.6.9 Screen Saver Setting

Supports 4 types of standby modes: black screensaver, time screensaver, clock screensaver, picture screensaver, and enter the screensaver state by default for 60S without operation in the menu interface. In the state of time screensaver and clock screensaver, if no operations in 60 seconds, indoor unit will automatically turn off the screen.

Picture screensaver:

1. Carousel the pictures in the SD card in the standby mode, after carousel one hour the screen will be turned off.
2. User need to create a folder named in “screensaver” in SD card, and put the pictures into the folder.
3. The pictures put in “screensaver” has below requirements:
Picture format is JPG
Picture resolution $\leq 1920 \times 1080$
Picture file size ≤ 3 MB

Note: From 0:00 am to 6:00 am, the monitor screensaver will be a black screen.

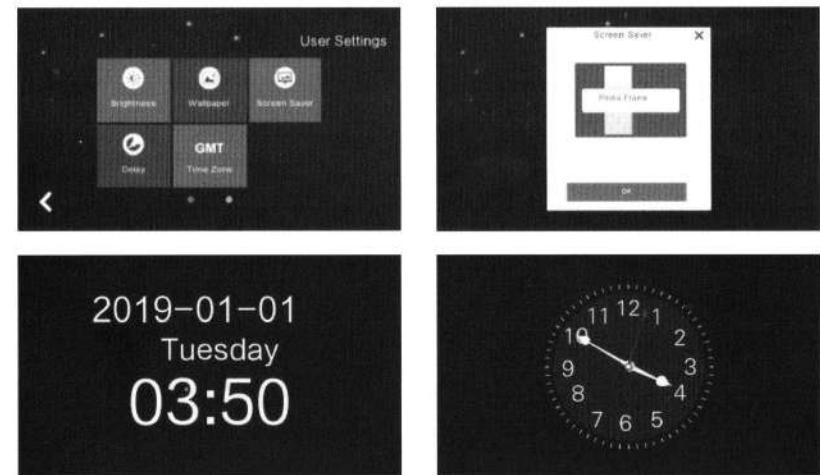

2.6.10 Delay Setting

8 delay settings are as following:

Ringing time (can be set to 5-90 seconds, the default is 30 seconds): the ringing time when the indoor unit is called.

No ringing time (can be set to 0-60 seconds, default 0 seconds): The non-ring time when the indoor unit is called, that is, the time from the end of the indoor unit ringing until the hang-up. During this period of time, no ringing. But can answer and hang up normally.

Screen saver time (can be set to 30, 60, 90 seconds, the default is 60 seconds): the time from no operation on the indoor unit until entering the screen saver.

Arming delay (can be set to 30, 60, 90 seconds, the default is 60 seconds): Set the time to complete the arming.

Alarm delay (can be set to 0, 30, 60 seconds, default 60 seconds): Set the time from when the alarm is triggered to the sound of the alarm sound.

Alarm sound duration (can be set to 3, 5, 10 minutes, the default is 5 minutes): Set the duration of the alarm sound after the alarm is triggered.

Indoor unit unlocking time (can be set to 5-60 seconds, the default is 5 seconds): Set the unlocking time of the lock connected to the indoor unit.

Doorbell ringing time (0-60 seconds, default 0 second): Set the ringing time of the external doorbell when the door phone calls.

After setting, click the Save button to save the setting.

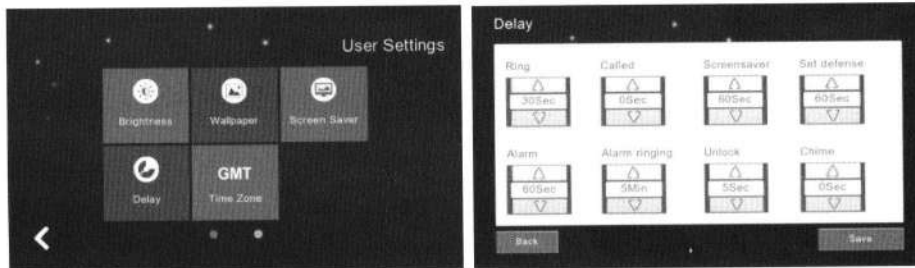

2.6.11 Time Zone Setting

Click "Time Zone" to enter the setting, and when selected one time zone, click "Setting" to set successfully.



2.7 System Settings

Click "System Settings" in Main GUI and input the system pin code "666 666" to enter the system settings.

: Click "One Circle Button" to enter the next user settings page.



2.7.1 Security Setting

Click "Security" to enter the setting menu that support to set "8 Security Area", "7 Security Type", and when you adjusted it that need to click "Save" to set successfully.



2.7.2 Monitor Extension Setting

Caution: Don't setting monitor extension before setting "Door" successfully.

Apartment System - Extension settings

After Door setup, click "Extension", and set the number for this monitor. The Extension in Apartment System need to set Area, Building, Unit, Floor, Room, Ext, and the Area and Building of the indoor monitor need to be the same as outdoor station.



High Level System - Extension settings

After set "Door", click "Extension" to enter the setting menu that input the extension number of the current monitor.

The extension number of the monitor should be set according to the type of the outdoor station (there are 4 types of the outdoor station: 1 button, 2 buttons, 3 buttons and 4 buttons). For example, is if the outdoor station is with 1 button, then the extension number of the monitor should be 0201. If the outdoor station is with 2 buttons, then the extension number of the monitor should be 0201, 0301; If the outdoor station is with 3 buttons and 4 buttons, then the extension number should be 0101~0301, 0101~0401.

The pre 2digit means floor number, last 2digit means extension number. If one room need more indoor monitor, then can set with Extension number, For example: Room 0201 need 3more monitor, can set them to be 0202, 0203, 0204. One room max support 4 monitor. When you input the extension number that need to click "OK" to set successfully.



Villa System - Extension settings

After Door setup, click "Extension" to set the current monitor extension, the range of the extension is 0-10. For instance, set as 01, and OK.



2.7.3 Outdoor Station Setting

While indoor monitor, high level outdoor station and villa outdoor station parameters all are under default condition, can set the new parameter for them here. (Remind:All machine will under default parameter after reset).

Reset indoor monitor: All parameter back to be default after reset. Please reference to the content of 2.7.5 (System Reset)

Reset high level outdoor station: Keep press the button on back for 3-5S till heard "Di" sound then release it. The outdoor station reboot with start on melody.

Reset villa outdoor station: Keep press call button 60s till heard "Di" sound and see the LED light turn on, then release it. Small outdoor station reboot with start on melody.

Need to make sure all the machine using same LAN while setting the outdoor station, it is default one monitor+one outdoor, if need outdoor station, please finish the setting of first one, then set the second one.

Apartment System: Can not set High level call panel. Need to set Area, Building, Unit, Floor, Room, Ext when set Door, like 01Area 01Building 01Unit 0101Room 01Ext.

High level System: High level Door extension range: 01-04 (Default max can support 4extension one house); The pre first 2digit mean the floor number(It is set according to the indoor monitor extension), the last 2 digit means extension number, for instance 01Floor01Ext (Default only connect one front door).

Villa System: Cannot set High Level at Door. Set the Extension while set Door, for example 01, range 01-06, default max support 6 villa call panel.

Set High Level outdoor station and Villa outdoor station via monitor: Door extension, Unlock time, Ring volume, Motion Sensitivity(Only happened on small outdoor station) .**Unlock time:** 1-150S; Ring Volume: 1-15; Motion detection sensitivity: 0-3(0 mean close, 1 means low level, 2 means middle level, 3 means high level)

Notes: When set High Level and Villa at Door setting, need to input the parameters one by one and then save with pres OK.

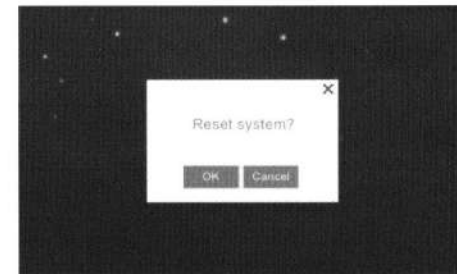

2.7.4 System Password Setting

Click " System Pwd " to enter the setting menu that input the old passcode "666 666" firstly. And new passcode need to input twice,then, click " OK " to set successfully .



2.7.5 System Reset

Click "System Reset" to have a notification whether "Reset system". And click "OK" to reset the system successfully that clean all settings what you changed and records in the monitor, then, it will be in the Factory Settings Default. Click "Cancel" will return the System Settings Menu.

2.7.6 IP Camera Setting

- 1). Support H264 IP Camera Protocol: Onvif (Reference Brand: HIKVISION or Dahua)
- 2). Access the IP camera with IE Explore, check if the video format is H264, and make sure the voice option is off.
- 3). When you connected the IP Camera, need to set "IP Address" in the same network segment between "IP Camera" and "Indoor Monitor".
- 4). Click "Add" to name "IP Camera" such as "Elevator Hall" and click "Enter/Enter". Then, input "IP Camera IP Address" such as "192.168.1.2"
- 5). "User" need to input "Administrator Name and Passcode" which is in User Manual of IP Camera, it will return IP Camera Menu and there is a camera name "Elevator Hall".
- 6). Click "Delete" to have IP Camera List and selected one, then, click "Delete" to have a notification whether delete it or not.

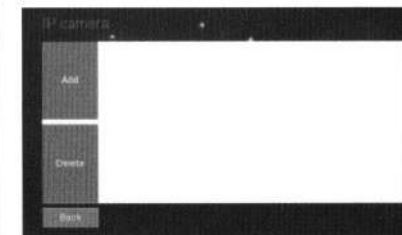

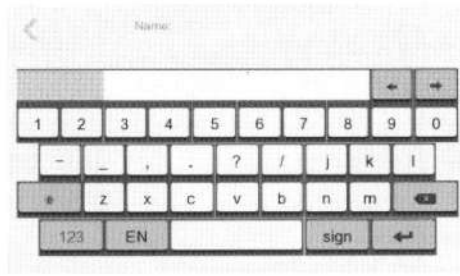

2.7.7 Color Adjustment

The contrast, saturation, and video color of the screen can be set. The parameter setting range is 0~99. After setting, click Save.

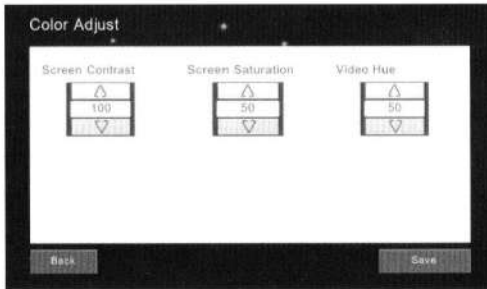

2.7.8 Software Upgrade

Caution: Don't shut off power during the software is upgrading or the indoor monitor will not work any more.

- 1). Support SD Card Software Upgrade that need to put "image.dd" and "NetCfg.dat" in related SD Card.
 - 2). Assembly SD Card in the indoor monitor and shut off power to reset the indoor monitor accordingly. Then, enter "Upgrade" menu as the above instructions.
 - 3). Select "NetCfg" or "Program" to upgrade the Program and Network Configuration separately.
- A. Select "NetCfg" firstly and click "OK" to upgrade the Network Configuration, it will reboot automatically to be upgraded successfully.

- B. Select "Program" firstly and click "OK" to upgrade the Program, it will reboot automatically to be upgraded successfully.

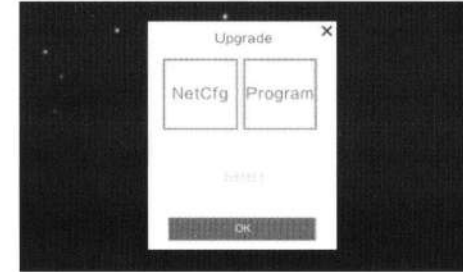

2.7.9 Record Mode Setting

"Record Mode" is including Record and Snapshot, to set the outdoor station record mode when the householder missed the call or answered the call. Record is "take the video of visitor" and Snapshot is "take the photo of visitor".

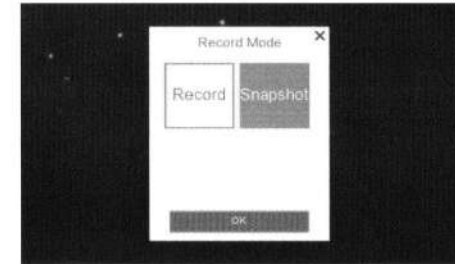

2.7.10 Outdoor Station Parameters Resetting

Support to review and change High level and Villa Outdoor Station Parameters.

- 1). Input "Door Extension Number" and click "OK" to have related door extensive parameters such as "Unlock Time", "Ring Volume", "Call Volume", "Motion Sensitivity", "Software Version".
- 2). Support to change the parameters, need to delete the previous parameters and input new ones. Then, click "OK" to change successfully.

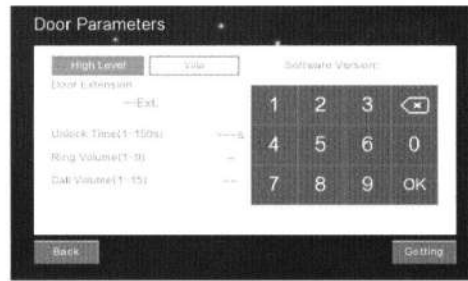
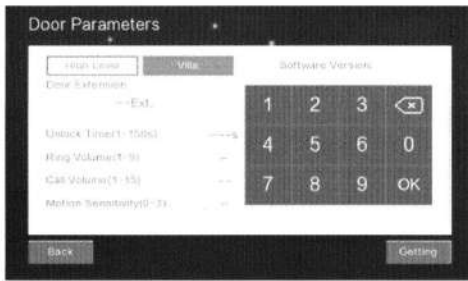

2.7.11 Card (only for high level system)

This function is valid for Outdoor Station with the card function, the details refer to its standalone User Manual.

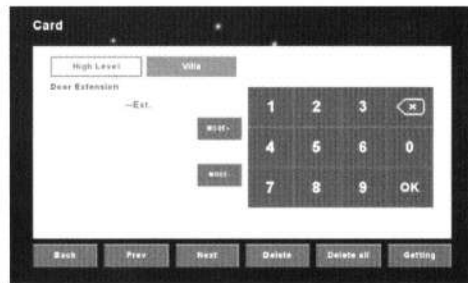
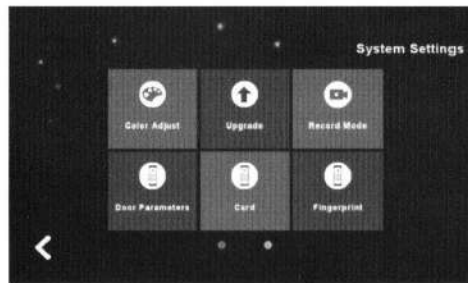

2.7.12 Fingerprint (only for high level system)

This function is valid for Outdoor Station with fingerprint function, the details refer to its standalone User Manual.

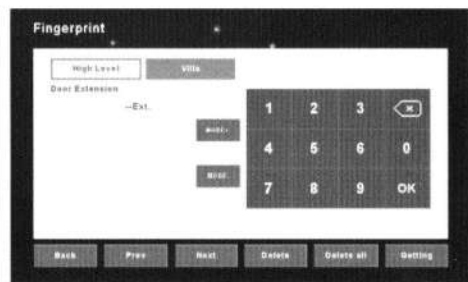

3 Technical Parameter

- Display: 7" TFT LCD(color) / 10.1" TFT LCD(color)
- Resolution: 1024*600
- Vibration: Bell ≥ 70 dB
- Power: DC 12V/2A
- Current: < 350 mA
- Working temperature: $-20^{\circ}\text{C} \sim +70^{\circ}\text{C}$
- Max power consumption: < 5 W
- Mension: 226mm*151mm*23mm
- Installation: surface mounted

4 Install The Indoor Unit



Note:

- Please be far from the devices with intense radiation: TV, DVR, etc.
- Do not disassemble privately to avoid the electric shock.
- Do not drop, shake or knock the device, otherwise will damage the elements.
- Choose the best position to install, the horizontal view is 150cm.
- Please power down before installation.
- Keep at a distance of more than 30cm with AC power to avoid interference.
- Away from the water, magnetic field and chemicals.

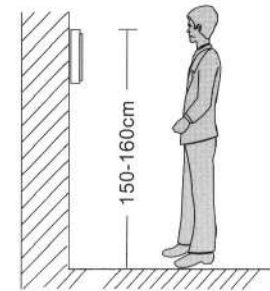

How to install the indoor unit

